

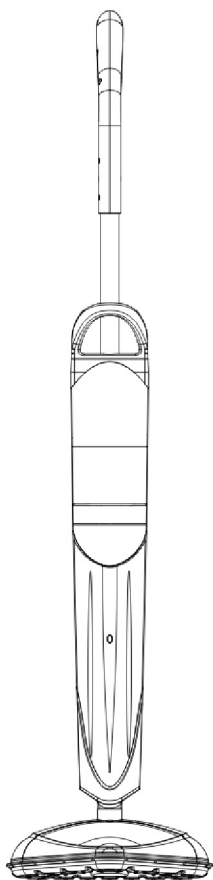

Steamboy **USER MANUAL**



MODEL: T1

IMPORTANT SAFEGUARDS

When using an electric appliance, basic precautions should always be followed, including the following:

READ ALL INSTRUCTIONS BEFORE USING THIS STEAM CLEANER

WARNING: DANGER OF SCALDING

To reduce the risk of fire, electric shock, or injury:

- This product is designed for domestic use only.
- Do not use outdoors.
- Do not leave steamer unattended while turned on. Unplug the electrical cord when not in use and before servicing.
- Do not allow to be used as a toy. Close attention is necessary when used near children, pets or plants.
- The appliance is not intended for use by young children or infirm persons without supervision.
- Young children should be supervised to ensure that they do not play with the appliance.
- Never direct steam towards people, animals or plants, or equipment containing components.
- Do not immerse the steamer into water or other liquids.
- Do not use with damaged cord or plug. If steamer is not working as it should, has been dropped, damaged, left outdoors, or immersed into water, return it to the distributor before continuing use. If the supply cord is damaged, it must be replaced by the manufacturer or a similarly qualified person to avoid a hazard.
- Do not pull or carry by cord, use cord as a handle, close a door on the cord, or pull cord around sharp edges or corners. Keep cord away from heated surfaces.
- Do not use extension cords or outlets with inadequate current carrying capacity.
- Unplug after use. Do not unplug by pulling on cord. To unplug, grasp the plug, not the cord.
- Do not handle plug or steam cleaner with wet hands or operate without shoes.
- Do not insert any objects into openings. Do not use with any opening blocked.
- Do not use without floor cloth in place.
- Do not use on stairs.
- Store your steamer indoors in a cool, dry area.
- Keep your work area well lighted.
- Never put cleaning detergents into the Steamer. This will make the operation unsafe and damage the unit.
- Use only as described in this manual. Use only manufacturer's recommended accessories.

SAVE THESE INSTRUCTIONS

KEY FEATURES OF STEAMBOY

- A) STEAMER HANDLE
- B) TRIGGER
- C) QUICK RELEASE CORD WRAP
- D) CARRY HANDLE
- E) WATER TANK
- F) FILTER
- G) STEAMER BODY
- H) LED
- I) LOWER CORD WRAP
- J) POWER CORD
- K) STEAMER HEAD
- L) CLOTH PAD
- M) CARPET GLIDER

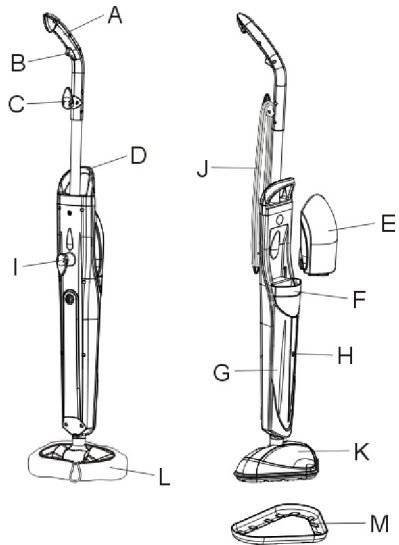

The following information is provided for service by a qualified electrician only:
Rated voltage: □ **110~120V, 60Hz, 1500W**

This appliance must be grounded. Use only the proper type outlet when plugging in the appliance, do not attempt to override the ground wire feature.

DESCRIPTION

Thank you and congratulations for choosing the Steamboy T1 floor mop. This Steamer is a new way of cleaning that is effective and far more hygienic than conventional methods.

The Steamer achieves a high degree of hygienic and decreasing cleansing power by converting water into steam using a micro fibre floor cloth enhancing absorbency. When contact is made with floor surfaces, dirt and grime can be eliminated in a matter of seconds.

Since the Steamer uses the active power of steam without the use of detergents or soap, it is environmentally friendly.

The Steamer does not require distilled water. Residents in areas with hard water should use distilled water for better performance.

When used correctly the Steamer can kill dust mites and some types of bacteria, such as salmonella and E-coli.

To disinfect a specific area, position the steamer over the area for a minimum of eight seconds. The steam temperature will reach to approximately 100° C (212° F). Use this procedure to disinfect **floors** near: bathroom stools, kitchen counters, pet sleeping quarters, etc.

INSTRUCTIONS FOR USE

The Steamer is designed to thoroughly clean floor surfaces, such as marble, ceramic, stone, linoleum, sealed hard wood floors and parquet.

WARNING: ON SURFACES THAT HAVE BEEN TREATED WITH WAX, THE WAX MAY BE REMOVED BY THE HEAT AND STEAM ACTION. DO NOT USE ON UNSEALED WOOD FLOORS OR LET UNIT STAND ON ANY WOOD FLOOR FOR AN EXTENDED PERIOD OF TIME. THIS COULD CAUSE THE WOOD GRAIN TO RISE. IT IS THEREFORE RECOMMENDED THAT A SAMPLE CLEANSING BE CARRIED OUT ON AN ISOLATED AREA OF THE FLOOR. IT IS ALSO RECOMMENDED THAT YOU CHECK THE USE AND CARE INSTRUCTIONS OF THE SURFACE FROM THE FLOOR MANUFACTURER TO ENSURE SUITABILITY TO STEAM CLEANING.

For first time use of the machine, please hold onto the switch to allow the water to get pumped to the steam chamber. The pump will make a louder noise during this initial operation.

HOW TO ASSEMBLE AND USE

- 1) Attach steamer head to steamer body.
- 2) Secure steamer head with the small Philips Head Screw until is fully tighten.

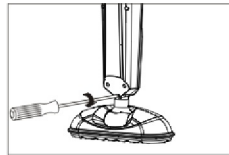
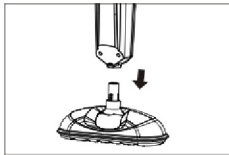

- 3) Insert steamer handle down into the steamer body.
- 4) Screw the Large Philips Head screw through the opening at the back of steamer body into the rear of the steamer handle and tighten until secure.

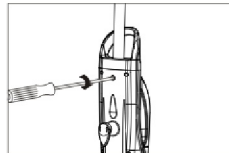
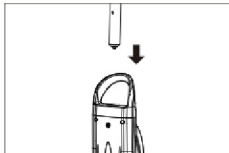

- 5) Place the steamer head in Cloth Pad, fasten Pad by pulling the cord while pressing on Toggle.

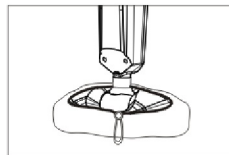
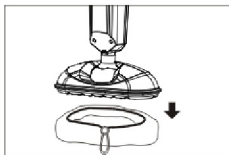

NOTE: Do not operate without a floor cloth in place.

6) Remove Water tank by lifting straight up and away from the unit, unscrew cap of the Water tank, remove the insert assembly, fill with cool tap water, replace the insert assembly and replace and tighten the cap. Replace Water Tank back to the unit.

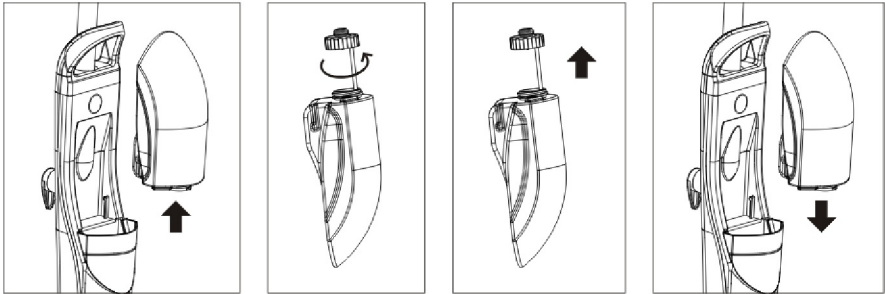

- 7) Twist the Quick Release Cord Wrap clockwise to unwrap the Power Cord completely and plug into a grounded outlet.
- 8) The LED will illuminate when the steamer is connected to power socket. Please wait for 20 seconds (heat up period) before pressing trigger. The steam unit is now ready for use.

NOTE: It is recommended that another high wattage appliance is not operated on the same circuit to avoid a circuit overload.

- 9) Slowly pass over surface to be cleaned while pressing trigger to emit steam. It is recommended to sweep or vacuum floor prior using the steamer.

CAUTION: TO SANITIZE AN AREA OF YOUR FLOOR, LEAVE THE STEAMER OVER AREA FOR A MINIMUM OF 8 SECONDS, BUT NO LONGER THAN 15 SECONDS. LEAVING THE STEAMER STATIONARY POSITION FOR A LONGER PERIOD THAN RECOMMENDED MAY CAUSE THE BUILD UP OF A PALE RESIDUE. THIS RESIDUE CAN BE REMOVED BY USING A DECALCIFYING PRODUCT OR WITH A FEW DROPS OF VINEGAR. (SEE TROUBLESHOOTING GUIDE)

WARNING: NEVER RUN THE STEAMER WITHOUT WATER. NEVER DIRECT STEAM AT ANY PERSON OR ANIMAL. USE STEAMER ON SEALED HARD FLOOR ONLY.

10) When steamer stops emitting steam, this will occur after approximately 20 minutes of use, simply remove the Water tank, refill, and continue cleaning.

11) When you finish your cleaning, unplug Power cord from outlet, empty the Water tank, carefully remove the Cloth Pad from Steamer Head, wind Power Cord around the Cord Wrap and store it upright in a dry area or hang by the storage hook.

CAUTION: THE CLOTH PAD MAY BE VERY HOT.

Instructions for use of Carpet Glider Accessory

Please ensure micro fiber cloth is attached as outlined previously.

Please place carpet glider on the floor in an upright position with the triangular flat surface facing downwards.

Please place Floor Steamer head on the glider as illustrated

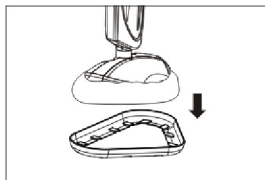

The Carpet Glider is now ready for use.

IMPORTANT

The Carpet Glider is designed **not to be fixed to the floor head** for safety reasons including the preventing burns

The carpet glider is designed **for use on soft carpeted areas only**. It is not designed for use on hard floor surfaces.

CLEANING AND MAINTENANCE

CAUTION: PRIOR TO CLEANING OR MAINTENANCE ISOLATE THE UNIT BY REMOVING THE CORD FROM THE POWER SOCKET. DO NOT IMMERSER THE UNIT IN WATER.

- 1) The micro fibre cloth can be machine washed in hot water and tumbled dry.
- 2) Wipe the steamer with a soft cloth.

The Steamer should only be used with its own specially developed floor cloths and Filter (spare Cloth Pads and Filters are available from your retailer)

TROUBLESHOOTING GUIDE

CAUTION: PRIOR TO TROUBLESHOOTING ISOLATE THE UNIT BY REMOVING THE CORD FROM THE POWER SOCKET.

PROBLEM	REMEDY
LED is not on.	Ensure Steamer power cord is correctly plugged into power outlet. Ensure circuit breaker is operational. Try operating the steamer from another power outlet.
No Steam	Ensure the water tank has correct level of water.
Pale residue left on the floor	Caused by leaving the floor steamer in the same position for too long. Can be removed with household white vinegar or a decalcifying product. Alternatively reheat the area for one minute and residue should be removed. CAUTION: Do not overheat area.

www.reliablecorporation.com