



Central Vacuum System Installation Guide



Index

Tool needed	Page 2
Typical installations	Page 3
Components of system	Page 4-5
Seven Step Installation	
Step 1: Choose your system	Page 5
Step 2: Plan number of inlets	Page 6
Step 3: Plan placement of inlets and unit	Page 6
Step 4: Plan the tubing installation	Page 7
Step 5: Install the inlet valves	Page 8
Existing home	Page 8-13
New construction	Page 13-14
Supervalue wiring instructions	Page 14-15
Step 6: Install the tubing	Page 16-18
Step 7: Install the power unit	Page 18-19
Central Vacuum Fittings	Page 20
Safety Instructions and Grounding Instructions	Page 21-22

TOOLS NEEDED FOR INSTALLATION

- ❖ Drywall saw (optional)
- ❖ Electrical tape/duct tape/cable ties
- ❖ Electric drill—1/2" (1.3cm) with right-angle head if possible
- ❖ Flashlight
- ❖ Forstner wood-boring bit—2-3/8" (2-1/2" if using PVC sch 40)
- ❖ Hammer
- ❖ Hole saw or cutter—2-3/8" (2-5/8" if using 2 inch PVC sch 40)
- ❖ Masonry bit—2-3/8" (2-5/8" if using PVC sch 40) (optional)
- ❖ Metal coat hangers
- ❖ Miter Saw
- ❖ Pencil
- ❖ Pipe/tubing cutter or hacksaw and miter box
- ❖ Safety goggles
- ❖ Screwdrivers (Phillips and flat blade)
- ❖ Steel tape measure
- ❖ Stud finder
- ❖ Utility/razor knife
- ❖ Wire stripper/cutter
- ❖ Wood chisel
- ❖ 30' (9.15m) piece of cord or string

HELPFUL HINTS FOR INSTALLATION

- **Use a tubing cutter for cleaner cuts.**
- **Use 2-3/8" wood boring bit similar to a Forstner bit, or a 2-5/8" wood boring bit if using 2inch PVC sch 40 Plumbing pipe**
- **Rent a right-angle drill if you do not have one.**

LOOK FOR OTHER HELPFUL HINTS INSIDE THIS MANUAL.

Typical Central Vacuum System Installations

 = Inlet  = Unit

Ranch-style bungalow

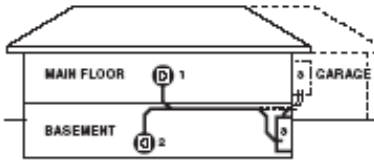

Single story on slab/crawlspace

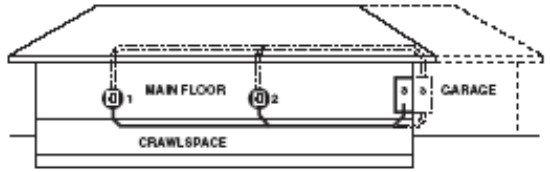

4-level split

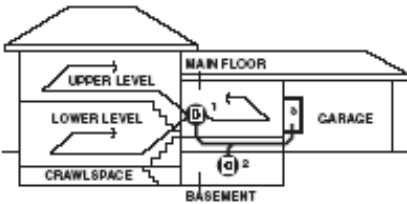

Large 4-level split

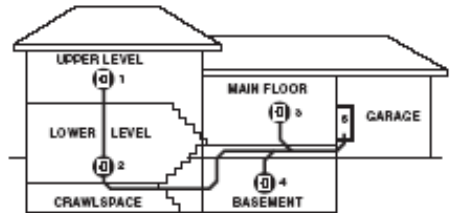

Two-story

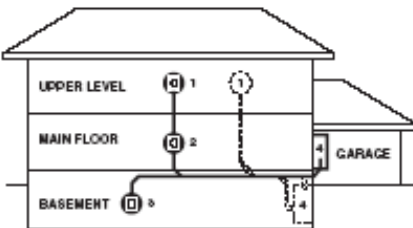

Large 3-level split

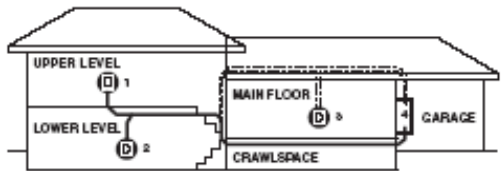

Seven Step Installation

Congratulations on the purchase of your new central vacuum system. It will make cleaning your home easier and improve indoor air quality. The system typically can be installed in virtually any home with no costly alterations and very little mess. This guide will show how to install your central vacuum system in just seven steps.

Read this guide and your unit's operating manual before you begin installation. Also, review your local building codes so your installation is in compliance.

Components of a Central Vacuum System.

1) **The Unit:** There are three main types to choose from; Paper Bag Filtered Systems, Cyclonic Action Systems (with drop down filters, cartridges, or washable filters), or True Cyclonic Separation Systems. The Unit is usually mounted in the garage, basement, utility room, storage room, or mud room to remove dust and allergens from living areas. Note: True Cyclonic units require venting to the outside. Other units may be vented to the outside as well.



2) **The Inlet Kit:** Choose from Standard Inlets or Electrical Inlets. Dust and dirt are carried through tubing from the inlet to the power unit. You may choose from 2in O.D. Central Vacuum tubing, or use 2in I.D. PVC Schedule 40 Pipe with adaptors. (See note on next page)

Sample of a (3) Inlet Kit with Vacuum Pipe



Note: Reasons to use our exclusive Patent Pending Adaptor Kits which enable you to use SCH 40 2in PVC plumbing pipe purchased locally.

- Using plumbing pipe will increase your CFM or your airflow by over 25%.
- 2in plumbing pipe is available almost anywhere. Vacuum pipe is limited mainly to central vacuum dealers.
- Plumbing pipe is much more substantial (thicker and stronger)

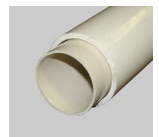

than vacuum pipe.

- Plumbing pipe comes in lengths up to 20FT which offers greater system performance requiring less cutting and gluing.
- Plumbing pipe works well under ground.
- Plumbing pipe offers less chance for clogs because of the larger diameter.

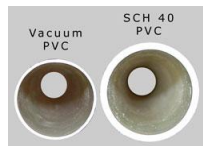

3) **The Attachment Set:** Choose from an Air Turbine Attachment set (shown below), Electrical Attachment set with an Electric Power head, or a Bare Floor Attachment Set. Sets consist of hose, wand(s) and various tools.



Installation Step 1: Choose your system.

You've already completed step number one...you've purchased your powerful, new system. Next, inventory the component parts that arrived with your central vacuum system kit and assemble the tools you will need. (See page 2.)

Inventory all the parts

Lay out the parts so you know you have them all and what each is called (reference page 21). A three-inlet valve system with pipe typically includes:

- | | |
|-----------------------------|----------------------------|
| (3) Inlet Valve Face Plates | (80) Ft Vacuum Tubing |
| (3) Mounting Brackets | (3) Short 90 Degree Elbows |
| (9) Sweep 90 Degree Elbows | (6) 45 Degree Elbows |
| (2) Sweep T | (13) Stop Couplers |
| (6) Pipe Straps | (1) Can Glue |
| (1) Cable Tie package | (80) Ft Low Voltage Wire |
| (1) Instruction Book | |

Installation Step 2: Plan number of inlets

To make sure your central vacuum system reaches every room throughout the house, you must first determine the number of inlets you will need and where to place them. One inlet valve can serve 700-800 square feet (63-72 sq m). Use only interior walls if possible, so you won't have to deal with insulation typically found in exterior walls.

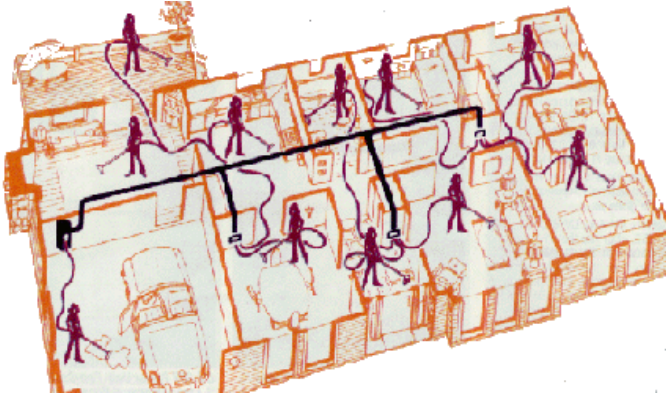

Note: If you are using the **Hide-a-Hose** System, please refer to the instructions that correspond with Hide-a-Hose.

Installation Step 3: Plan placement of inlets and unit.

Choose the best place for the inlet valve.

Good locations are centrally located in hallways or closet walls and/or doorways. Do not place inlets behind doors or furniture. Use a stud finder, or sound-out the wall, to make sure the site for the inlet valve is between the studs and that the space is open behind the wall board. Also check the other side of the wall to make sure it's clear of obstructions such as utilities and outlets. **Caution: Do not install an inlet behind a door or in a wall that has a pocket door.** Then have a helper hold the end of the hose at the proposed site for the inlet valve and take the other end and walk around the room(s). If you have no helper, use a piece of cord or string that is 30 feet (9.15m) long—the length of the hose. You want to be able to reach everywhere from floor to ceiling even with furniture in the way. You may have to choose a different location or add another inlet to cover the entire floor. Remember, one inlet typically covers about 700-800 square feet (63-72 sq m). Repeat this step on each floor of your home.

What about installing inlet valves upstairs?

Because there are finished walls above and below the second-floor sole plate, installing inlet valves upstairs can take a little more ingenuity. There are several options. Place an inlet outside a closet wall and then run the tubing through the wall and through the inside of the closet and down (see Fig. 03, Page 11). Another option is to run the tubing up into the attic then across and down to the inlet. Yet another solution is to install the upstairs inlet valve directly into the floor. (see Fig. 04, Page 12)

Existing home: If choosing an electric power head, the inlet valve must be within 6 feet (1.83m) of an electrical outlet. A switch on the handle sends a signal through “low-voltage” (24 volt) wiring to turn the power unit on and off.

New construction: If your home is under construction, you should consider using electric inlets. Electric valves have low-voltage and household wiring connections built in, so there’s no need for a nearby electrical outlet. Inlet valves should be installed before drywall is hung. Installation must be coordinated with an electrician to install the electrical wire after the tubing has been installed.

Choose where to mount the power unit.

To be sure that dust and dirt are effectively removed from living areas in your home; mount the power unit in your attached garage. If you do not have an attached garage, a basement, utility room, storage room or mud room is the best alternative location. Find a location near an electrical source with plenty of room for air to circulate on all sides of the unit. You’ll need a dedicated 15- or 20-amp circuit. Check the owner’s manual for your unit’s specifications.

Installation Step 4: Plan the tubing installation.

Before you install tubing to carry dust and dirt to the power unit, plan your route. Running the tubing beneath the sub-floor whenever possible makes tubing easier to work with and creates the shortest path between the inlet valves and the power unit. If the tubing has to run next to a water heater or chimney flue—for your safety and to comply with building codes—use metal central vacuum system tubing for that section. If the tubing runs through an unheated, cold or other unprotected environment, wrap it with insulation to prevent condensation and the possibility of clogging.

Installation Step 5: Install the inlet valves

Existing home inlet valve installation.

Directly beneath the proposed inlet site, use a flat-bladed screwdriver to wedge the molding aside. Then, take a wire coat hanger and snip a long straight piece from it. Insert the wire into the chuck of your drill and then holding the drill vertically beneath the intended inlet site, slowly drill down into the floor alongside the baseboard or where the wall and floor intersect. Release the wire from the drill chuck and leave it in the pilot hole to serve as a locator. Then go to the basement and look for the wire protruding from the ceiling.

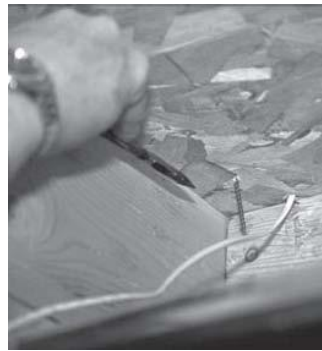

Now you can see where the inlet valve is going to be above you. Measure from the wire to find the center of the sole plate and wall cavity. **Note: You may want to drill a 3/4" (1.9cm) diameter inspection hole to avoid cutting into the bottom of a stud or other inner-wall obstructions.** Then using a flashlight and/or probe, inspect the interior of the wall to be sure there are no obstructions. If there are obstructions, you may have to move the inlet site. If there are no obstructions, drill a 2-3/8" diameter hole in the bottom of the hollow wall through the sole plate. Make sure to cut in between the walls. Vacuum tubing is 2" in diameter, so the hole will give you room to manipulate the tubing and the low voltage wire. If you are using PVC Schedule 40 Pipe, drill a 2- 5/8" diameter hole. Again, check for obstructions using a flashlight and a length of tubing. If there are no obstructions, go back upstairs and mark the inlet location on the wall. To do that, at the electrical outlet adjacent to the inlet site, measure up from the floor to the center of the outlet. At the proposed inlet site measure up from the floor the same distance. This will be the center of your inlet valve. If you prefer, you may locate the inlet at a more convenient height. Some homeowners prefer the inlet at fingertip height, about 30" above the floor.

Installing an inlet valve.

Take a wall mounting bracket, cut or snap off the new construction flange and dispose of it. (In new construction, nail the tab to the stud. See New Construction inlet valve installation.) Use a level to make sure the mounting bracket is level. Then trace the outline of the mounting bracket onto the wall. The top and bottom cuts are critical since the flange will rest on these areas. Take a utility knife and score the lines. Then use the utility knife or a drywall saw to cut a hole through the drywall. **Hint: A drywall saw makes the job easier.**

Attach a Short 90 Degree Elbow to the flange on the back of the mounting bracket. **Note: The ends of the Short 90 Degree Elbow are marked to accommodate walls of different widths.** Apply glue around the outside of the mounting bracket flange and twist the Short 90 Degree Elbow into place. Make sure the open end faces the direction it will meet the tubing—usually straight down. (If tubing has to run from the attic, the opening of the Short 90 Degree Elbow will face upward.) **Caution: Never apply glue to the inside of fittings or tubing.** Apply glue only to the outside of the tubing. This will prevent glue from creating obstructions which could clog your system.

Run about 6" (15.24cm) of low-voltage wire through the guide hole in the mounting bracket. Split the wire into two strands and strip 1" of insulation from each strand. Wrap the strands in a clockwise direction around the screws on the back of the inlet valve. Tighten the screws.

Now attach a weight to the end of the low-voltage wire and drop it down to the basement or crawlspace.

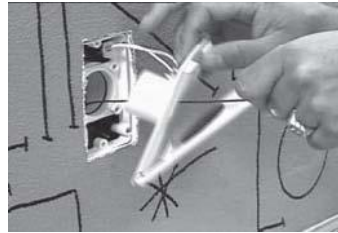
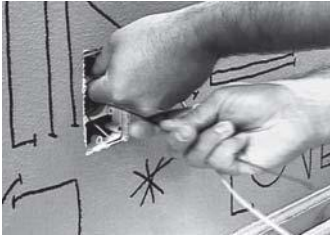

Have a length of wire coat hanger ready with one end bent into a hook. Insert the mounting bracket into the wall hole...first down...then up...centering it. Take the hanger and insert the hooked end of the hanger into the Short 90 Degree Elbow to hold the bracket in place. Then, slide the inlet valve face plate along the wire hanger into the mounting bracket. Screw the valve into place. Remove the wire hook. Be sure to mount the inlet valve face plate so the lid pulls down to open. Then apply glue to an adequate length of tubing and aim it upward through the hole in the sole plate and into the Short 90 Degree Elbow on the back of the mounting bracket. (See Installation Step 6 for information on installing tubing.)

Need more space?

If you cannot locate a hollow wall, or the space between your walls isn't wide enough, there are two alternatives: One is to run the tubing through a concealed area, such as the inside of a closet, then run the tubing downward. (A floor mounted inlet is another alternative. See page 12).



To run tubing through a closet, mount the inlet outside the closet and run tubing into the closet and down through the closet floor. Use a Stop Coupler on the mounting bracket along with a small piece of vacuum pipe.

Closet wall installation.

Often, the only practical solution is to install your system with the tubing going through a wall into a closet, then down through the closet floor. To use this method, select a suitable inlet valve location outside a closet—exercising the same precautions as for normal wall installation. Then, using a length of coat hanger, drill a hole through both walls (**Fig. 01**). Hold the wire perfectly horizontal so the interior and exterior holes line up with one another. Check for inner wall obstructions by bending a short length of coat hanger wire at a right angle and twirl the right angle piece inside the wall. If there are no obstructions, drill a 2-3/8" hole horizontally through both walls.

Drill Horizontal and Vertical Hole with Coat Hanger

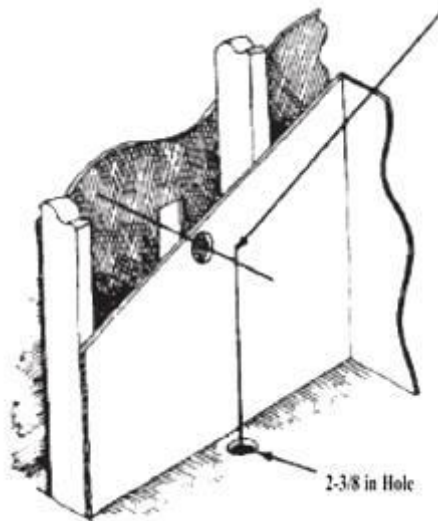

Fig. 01
Closet Wall Installation In An Existing Structure

Enlarge the hole in the exterior wall to accommodate the inlet valve assembly (valve face plate and mounting bracket) as described on previous page in "Installing an inlet valve." Inside the closet, drill a pilot hole through the floor beneath the opening in the wall or in a convenient location nearby to check for obstructions. If there are no obstructions, cut a 2-3/8" hole through the floor. Run low-voltage wire through the hole in floor and through the wall to exterior of closet. Pass low-voltage wire through the wire guide hole in the inner wall closet assembly (Fig. 02) and tape or cable tie low-voltage wire to this assembly immediately behind the bracket.

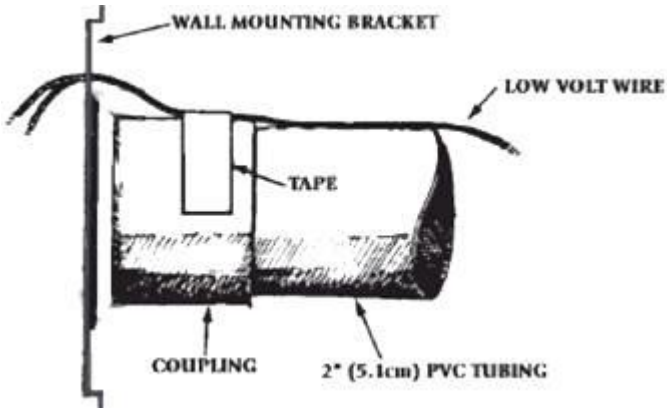

Fig. 02
Inner-Wall Closet Assembly

Place the inner wall assembly lengthwise through the wall opening and arrange the assembly so the bracket is flush with the inside surface of the wall. Attach wires to low-voltage terminals on the back of the inlet valve faceplate as previously described. Screw the inlet valve face plate to the wall bracket (Fig. 03).

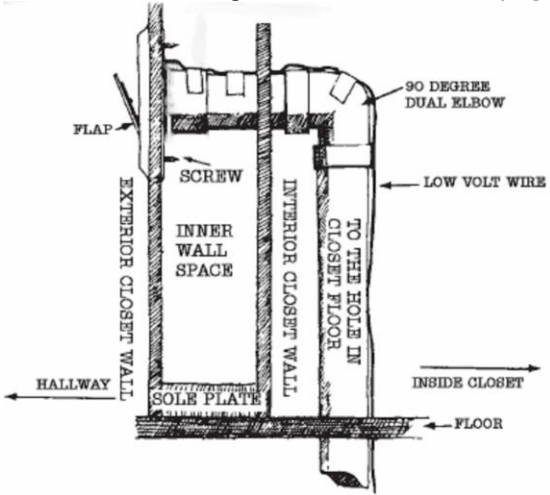

Fig. 03
Inner-Wall Closet Assembly - Installed

Floor valve installation.

To install a floor inlet valve, drill a pilot hole with a wire coat hanger and check the location as previously described. When you are sure that the proposed location will not be blocked by a joist or other obstruction, cut a hole in the carpet slightly larger than your 2-3/8" drill bit. Drill a 2-3/8" hole in the floor. Enlarge the opening to accommodate the low-voltage connections. Assemble a Floor Mount Adapter and attach the low-voltage wire to the inlet valve. Drop the low-voltage wire to the basement. Screw the valve to the floor. Repeat until all inlets are installed. **Note: Although plastic inlet valves are acceptable as long as they're installed next to the wall where no one will step on them, metal floor inlets provide added durability. Hint: Do not install floor inlets where furniture will be.**

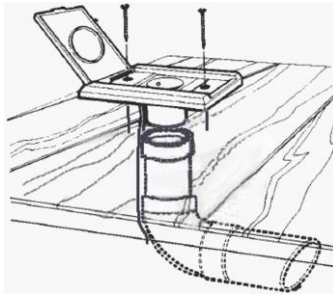

Fig. 04

Multi-story homes

Multi-story homes usually require one or more inlets on each level. Instead of trying to line up inlet valves from one level to the next, run a separate line of tubing from the upstairs inlet valve to a branch line or to the main trunk line (**Fig. 05**).

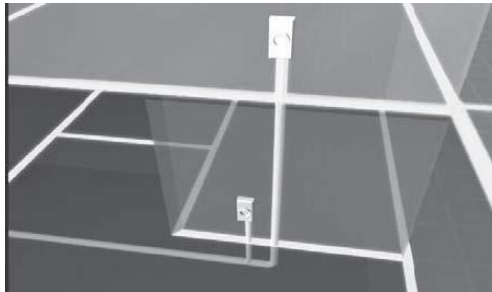

Fig. 05

In a two-story home, upstairs beneath the site you've selected for the inlet valve, cut a hole just large enough to allow you to reach the second-floor sole plate.

Hint: Cut the hole low in the wall for easier drilling through the sole plate.

Cut a 2-3/8" hole in the sole plate. Install the inlet valve as previously instructed. Then, from the basement, insert a length of tubing long enough to reach through the hole in the second floor sole plate to the site for the inlet valve. You may have to join several lengths of tubing. Measure and pre-cut these pieces and test-fit them

before gluing. When applying glue, work quickly to prevent the glue at the top end of the tubing from drying before it reaches the fitting at the inlet valve.

Remember, apply glue only to the outside of the tubing.

Hint: When upstairs, remember to aim the elbow downward. Other ways to reach the upstairs in your home are through the interiors of closets or pantries, beneath a staircase, or with floor inlets. If the inlet valve will be serviced from the attic, shorter pieces of tubing joined by couplings may be required because of overhead space restrictions. Again, measure, test fit and when gluing, work quickly to prevent the glue from drying before the tubing reaches the inlet valve.

Installing a VacPan.

A VacPan is a very popular option for the kitchen, mudroom and bath. Here are some tips for installation. First, determine the best place to install the dustpan; either under a cabinet (**Fig. 06**) or in the wall. Keep in mind that the leading edge of the VacPan must sit flush with the finished floor. **See VacPan Installation Instructions for details**



VacPan Automatic Dustpan Inlet

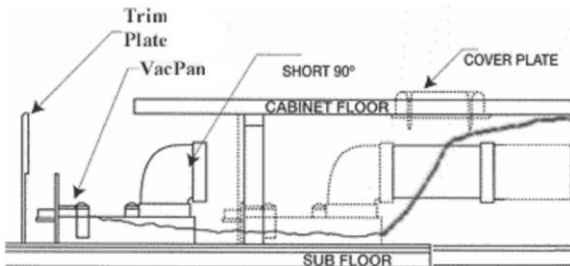

Fig. 06

VacPan Under Cabinet Installation

Note: Do not glue short 90

New construction inlet valve installation.

Select a site for the inlet valve and drill a pilot hole through the floor. Go below to check that the tubing path is clear of present, or future, obstructions such as floor joists, heating ducts, plumbing, wires, etc. At the inlet valve location, drill a 2-3/8" diameter hole through the sole plate. The hole should be 2" from the side of the stud and centered between the front and back edges of the sole plate (**Fig. 07**).

CENTERLINE OF TUBING OPENING IN WALL
 ADAPTER IS 2" (5.1cm) FROM FRONT OF SOLE PLATE
 AND 2" (5.1cm) FROM SIDE OF STUD

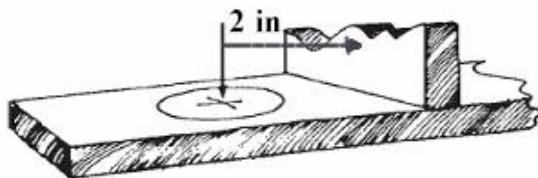

Fig. 07

Glue a length of tubing into a stud-mounting bracket assembly. Cut a length of low-voltage wiring, bring approximately 6" through top wire guide hole in stud bracket assembly and double it back into elbow hole. Tape wire to tubing at assembly elbow and again close to end, and tuck remaining wire into bottom of tubing. Screw Plaster Guard onto face of assembly (**Fig. 08**).

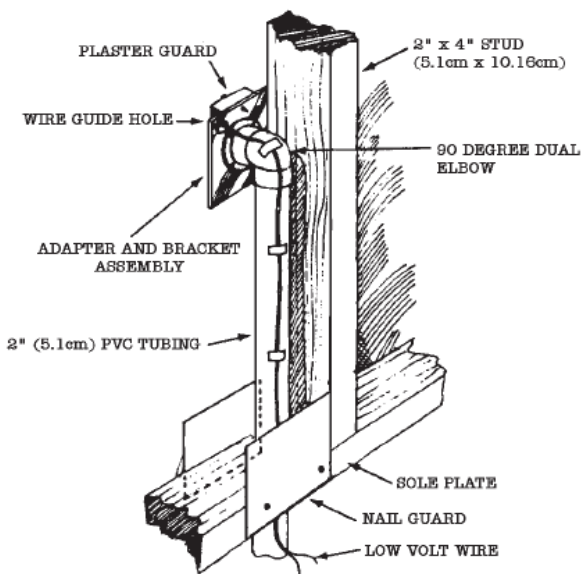
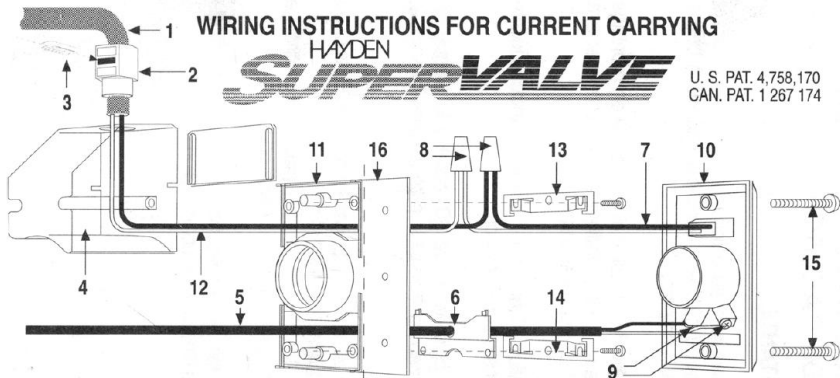

Fig. 08

Stud-Mounting Bracket Assembly (New Construction)

Drop bottom of tubing through 2-3/8" hole and nail mounting bracket assembly to stud. Make sure the center of the inlet hole is at the correct height above floor level and the tubing extends below the sub-flooring. To prevent a nail or screw from penetrating the vacuum tubing, install nail guards on the sole or top plates adjacent to the tubing. See "Installation Step 6: Install the tubing" and complete tubing installation as much as possible. After the walls are finished and painted, plaster guards can be removed and inlet valves installed. The tubing system may be completed at that time and the power unit installed.



NEW CONSTRUCTION

1. Install BUILDING WIRE CONDUCTORS (1) through the approved type electrical CONNECTOR (2) (supplied) until they protrude approximately six inches from connector. Seat connector firmly into the opening atop the WIRING COMPARTMENT (4). Insert and secure LOCKING TAB (3).

2. Splice wires from INLET VALVE RECEPTACLE (7) to the protruding building wire conductors with #31 TWIST-ON WIRE CONNECTORS (8) (not supplied).

NOTE: *White wire to white wire & black wire to black wire.*

3. Feed LOW VOLTAGE RELAY WIRES (5) through opening in the LVT COVER PLATE (6) and connect to the two contact screws of INLET VALVE FACE PLATE (9).

4. Push Inlet Valve face plate (10) into MOUNTING PLATE (11). At the same time, push ELECTRICAL CONDUCTORS (12) and connectors (8) into WIRING COMPARTMENT (4). Back out the two screws that hold the wiring compartment in place. Slip upper FINISHED WALL CLIP (13) under the screw heads and tightly fasten both wiring compartment and upper finished-wall clip (13) with MOUNTING SCREWS (supplied).

5. Install the lower FINISHED WALL CLIP (14) with screws (supplied).

6. Secure Inlet Valve face plate **(10)** to mounting plate **(11)** using the two supplied color matched SCREWS **(15)**.

FINISHED CONSTRUCTION

After pipe, low voltage relay control wire, electrical building wires and opening in wall has been cut:

1. Remove mounting plate NAILING FLANGE **(16)**. Use a hack saw or score with razor knife along dotted line and snap off.
2. Repeat step one (from NEW CONSTRUCTION).
3. Install modified mounting plate with short 90° ELL glued in position into wall opening.
4. Repeat steps 2-6 (from NEW CONSTRUCTION).

Installation Step 6: Install the tubing.

(Existing Home or New Construction)

Beginning at the inlet farthest from the power unit, temporarily fasten tubing for the main trunk line into position. **Hint: Loop string or low-voltage wire to create a hanger strap from a nail or overhead pipe to cradle the tubing and hold it in position while you work.**

Push a length of tubing up into bottom of the elbow on the inlet valve assembly. Piece together sections of tubing without glue at first to make sure things fit properly. Mark the connections so you can re-assemble them the same way. Remember, the tubing enters the fitting approximately 3/4". Measure, cut, and de-burr tubing, and, using a Sweep 90 Degree Elbow, slip-fit the vertical tubing line to the main horizontal line. To avoid potential clogging problems when installing tubing and fittings:

- **Make straight cuts on tubing (pipe/tubing cutter works well or a miter saw).**
- **Remove burrs from ends of tubing.**
- **Be sure tubing fits against the shoulder of the fitting with no gaps.**
- **Glue only the outside edge of the tubing before assembly into fittings.**
- **Push and twist the pipe and fittings together**

Connect tubing from additional inlet valves to the main trunk line using a Sweep T. (**Fig. 09**) and use clamps to hold the sections in place. Be sure to install the Sweep T so the sweep is toward the power unit (**Fig 10**)

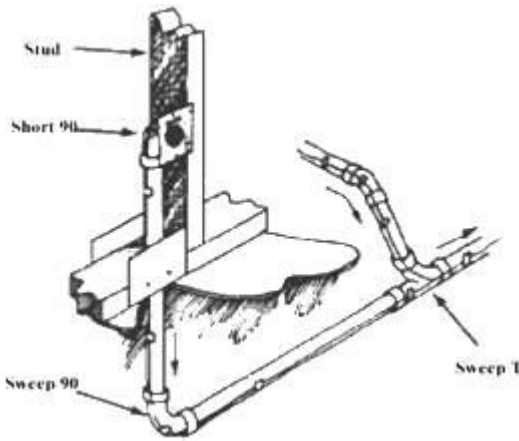

Fig. 09
Typical Under-Floor Installation

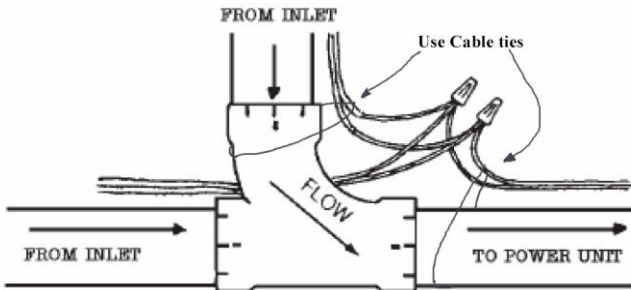

Fig. 10
Sweep T Direction

String the low-voltage wire along as you assemble the tubing. Join or splice low-voltage wires with wire connectors at each junction or branch of the tubing. Use Cable ties to secure connections. To make sure the polarity is right; always attach wires of the same color to each other – typically copper to copper and silver to silver. Proceed until the tubing system is complete.

Hint: Create clamps from extra tubing to hold low voltage wire in place or use cable ties.



Masonry or concrete walls

If you have to run tubing through masonry or concrete walls, rent a hammer drill and/or masonry hole saw. Run the tubing through and patch the hole when installation is complete and system is running properly. Before drilling, check local building codes for special firewall penetration regulations. The code should tell you if steel tubing or firestop couplers are required for firewall penetration.

Installation Step 7: Install the power unit.

Attach the power unit to the wall within six feet of a grounded electrical outlet ensuring it will be easily accessible for emptying the dirt receptacle, at least 18" from the floor. For proper motor cooling, there must be at least 12" between the unit and the ceiling. **(Fig. 12)** Do not install the power unit where the ambient temperature regularly exceeds 120 degrees Fahrenheit (48.9 degrees C).

If mounting on plaster, wall board or panel walls, be sure mounting bolts enter studs. If mounting on a block or concrete wall, drill the holes with a masonry bit and insert plastic or lead anchors. As an alternative to mounting on concrete walls, suspend 2" x 4" (5.1cm x 10.16cm) studs or plywood from overhead.

To attach the low-voltage wires, strip the wire and crimp the strands into the two "slip-on" (spade) terminals provided. Attach the terminals and plug the power unit into the dedicated electrical outlet. The sentry light should come on. Turn on the switch, if applicable, and the power unit should turn on. Attach the remaining section of tubing to the power unit with connector(s) and clamp(s) provided.

Caution: Do not glue the connection because you may need to disconnect the system at a future date. For added installation convenience, some power units may have inlet connections on either side. If your system came with a muffler, clamp it to the exhaust port.

NOTE: True Cyclonic units must be vented to the outside. Other units may be vented to the outside as well. Use the same tubing and fittings. If vented, the exhaust air should not be vented into a wall, ceiling or concealed space of a building. Venting over 10 feet (3m) is not recommended.

Power unit electrical wiring.

Check local codes but use not less than #14-3 wire. Plug power unit cord into appropriate 120/220/230/240V — 50/60 cycle electrical outlet. Be sure line voltage is sufficient to handle a 15 or 20 amp load. See your owner's guide.

Figs 12

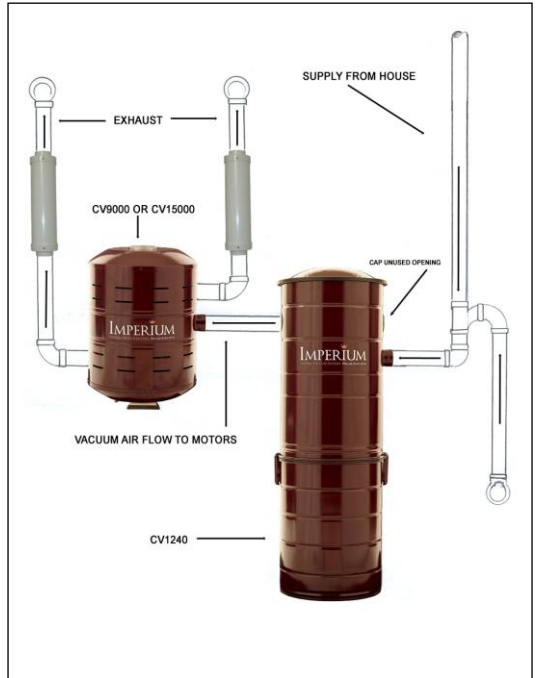
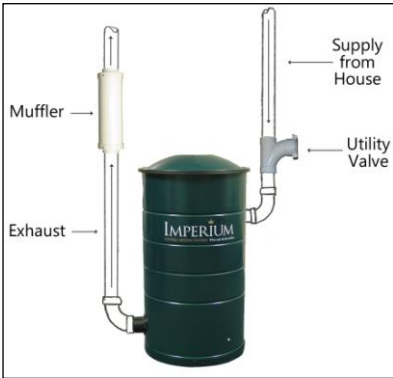
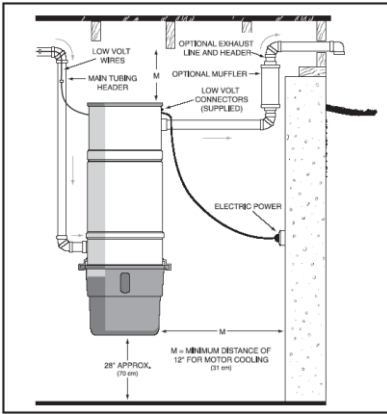























Check your installation to make sure it works properly.

- 1) Check to see if you have a closed system. With no hose or handle attached, and all inlet valves closed,
- 2) there should be little or no air coming through the exhaust of the power unit when it is turned on.
- 3) With the system still running, walk through your home. If you hear whistling or hissing, you may have forgotten to glue a connection. Check basement and attic areas, too.
- 4) Have a helper plug the hose into each of the inlet valves to be sure you can turn the power on. Turn off the switch on the hose handle, if applicable, and the unit should turn off. If the unit does not turn off and on as required, you may have low voltage wires reversed, cut or disconnected.

That's it! You've just installed your own central vacuum system and made cleaning easier... while improving the air quality in your home.

Congratulations!

Central Vacuum Fittings

	45 Degree Elbow		Sweep T		Short Tee
	45 Wye		45 Degree Spigot (Street)		Stop Coupler
	Short 90		Short 90 Degree Spigot (Street)		Trim Ring
	Sweep 90		Medium 90 Degree Spigot (Street)		Inlet Trim Plate
	3 Way ELL Sweep (Y Sweep)		Sweep 90 Degree Spigot (Street)		Pipe Cap
	Pipe Strap		Vac Tube to Sch 40 2x2 Adaptor		2x1 3/4 Adaptor (Kenmore)
	Inlet Valve Extension		Firestop Coupler		Floor Mount Adapter
	Plaster Guard		Nail Guard (available at a hardware store)		

IMPORTANT SAFETY INSTRUCTIONS

When using electrical appliances, basic safety precautions should always be followed, including the following:

DANGER: Always unplug power unit from the electrical outlet before servicing and cleaning.

WARNING: To reduce the risk of burns, fire, electric shock or injury to persons:

1. Keep cord away from heated surfaces.
2. Do not allow to be used as a toy. Close supervision is necessary when this vacuum is used by or near children.
3. Use this vacuum only for its intended use as described in the operating and maintenance manual. (Use of attachments not recommended by the manufacturer may cause fire, electric shock or injury.)
4. Never operate this vacuum if it has a damaged cord or plug, if it is not working properly or if it has been dropped or damaged. Return to service center or have service person examine and repair.
5. Do not pull or carry this power unit by supply cord, use cord as a handle, close a door on cord or pull cord around sharp edges or corners.
6. Never disconnect plug by pulling on cord. To disconnect from outlet, grasp the plug, not the cord.
7. Do not put any object into openings. Do not use with any opening blocked.
8. Keep hair, face, fingers and loose clothing away from any openings.
9. Do not pick up cigarettes, hot ashes, matches or similar materials.
10. If required, never operate vacuum without dust bag and/or filter in place.
11. To disconnect, turn all controls to the OFF position, then remove plug from outlet.
12. Never handle plug, cord or power unit with wet hands.
13. Electric shock could occur if used on wet surfaces.
14. Use extra care when cleaning on stairs.
15. Do not use to pick up flammable or combustible liquids such as gasoline or use in areas where they may be present.
16. For a grounded appliance: Connect to a properly grounded outlet only. See grounding instructions below.

GROUNDING INSTRUCTIONS

This appliance must be grounded. If it should malfunction or break down, grounding provides a path of least resistance for electric current to reduce the risk of electric shock. This appliance is equipped with a cord that has an equipment-grounding conductor and grounding plug. The plug must be plugged into an appropriate outlet that is properly installed and grounded in accordance with all local codes and ordinances.

WARNING

Improper connection of the equipment-grounding conductor can result in a risk of electric shock. Check with a qualified electrician or service person if you are in doubt as to whether the outlet is properly grounded. Do not modify the plug provided with the appliance—if it will not fit the outlet, have a proper outlet installed by a qualified electrician. This appliance is for use on a nominal 120-volt circuit and has a ground plug for North American units. For 220/230/240 volt units, consult your local building code/electrician. Make sure that the appliance is connected to an outlet that has the same configuration as the plug. No adapter should be used with this appliance. Check power unit On/Off switch and all inlet valves for operation. This power unit is intended for household and commercial use.

WARNING: ELECTRIC SHOCK COULD OCCUR IF USED ON WET SURFACES.

Read all instructions before using this vacuum.

NOTE: Your central vacuum system is listed and approved by the appropriate agencies for dry pick-up only. Please see your rating plate for details. To reduce the risk of electric shock, DO NOT USE outdoors or on wet surfaces.

SAVE THESE INSTRUCTIONS

Your machine

Model number: _____

Serial number: _____

Date of purchase: _____



Central Vacuum Stores
3015 46th Ave N
St Petersburg, FL 33714
www.centralvacuumstores.com
(727) 526-5188 1-800-221-8227